

SSL Interface Controller for Analog (0-10V), PWM, and Resistor Dimming with Optocoupler Delay Elimination

1 Description

The iW350 is a PWM signal generator that works with three different types of dimming inputs, 0-10V PWM dimming, 0-10V linear dimming or simple dimming using a single resistor to ground from the DIM pin. The iW350 auto detects the dimmer type connected. A PWM dimming type is directly used, while the 0-10V linear dimming and resistor dimming signals are converted into a 0%-100% PWM duty cycle that can then be used to provide a dimming signal to a primary-side LED driver such as the iW3636, removing the need for transformers or other driver circuitry. The output of the iW350 is optimized in such a way as to remove the impact of the non-linear delay typical of optocouplers.

The iW350 offers a high level of flexibility by offering programmability for the maximum dimming voltage, minimum output duty cycle and the turn-off threshold voltage through external resistors. The output PWM frequency is also programmable from 100Hz to 5kHz through a single capacitor to ground. The input to the iW350 integrates the necessary current source to interface with both active and passive 0-10V dimmers without additional circuitry, while the output can drive an optocoupler to provide isolated dimming control from the secondary to the primary.

2 Features

- 15V to 60V operating voltage
- 3-in-1 dimmer interface
 - » 0-10V PWM dimming
 - » 0-10V linear dimming
 - » Single resistor dimming
- Dimmer type - auto detect
 - » PWM or DC input dimming signal
- 0% to 100% PWM output
 - » 1% PWM duty cycle tolerance
 - » Selectable frequency range via external capacitor
 - » Unique duty cycle drive to account for non-linear optocoupler delay
- SOIC-8 package
- External resistor configuration
 - » Programmable max dimming voltage: 8.5V, 9V, 9.5V and 10V
 - » Programmable minimum duty cycle: 1%, 3%, 5% and 10%
 - » Programmable turn-off threshold: 0.5V, 0.6V, 0.7V and 0.8V
- Programmable PWM output frequency range: 100Hz-5kHz
- Integrated current source for driving 0-10V dimmer
- Low power shutdown mode
- Integrated optocoupler driver for isolated applications

3 Applications

- 0-10V LED dimming application
- 3-in-1 LED driver interface chip (0-10V linear, 0-10V PWM and R dimming) dimming LED driver application

SSL Interface Controller for Analog (0-10V), PWM, and Resistor Dimming with Optocoupler Delay Elimination

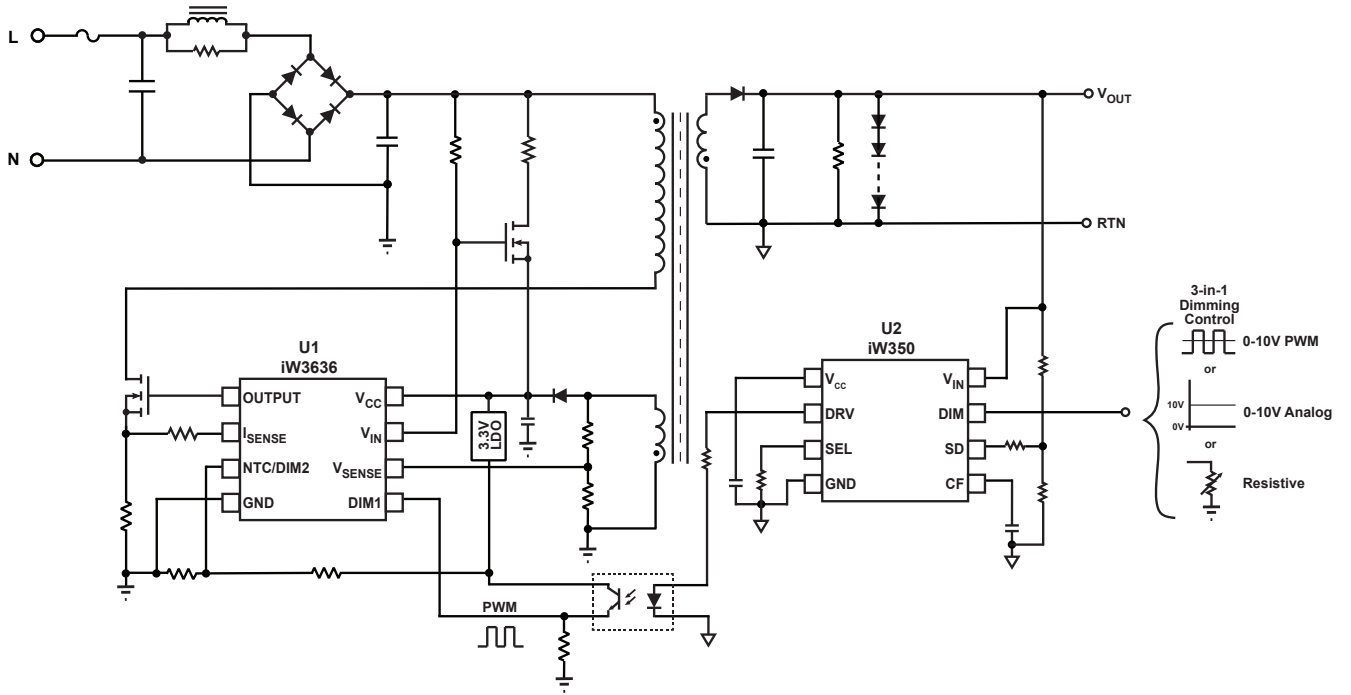

Figure 3.1 : iW350 Typical Application Circuit

SSL Interface Controller for Analog (0-10V), PWM, and Resistor Dimming with Optocoupler Delay Elimination

4 Pinout Description

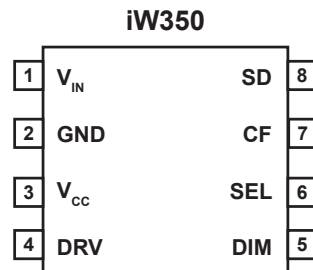

Figure 4.1 : 8-Lead SOIC Package

| Pin Number | Pin Name | Type | Pin Description |
|------------|-----------------|---------------------|---|
| 1 | V _{IN} | Power | Power supply up to 60V. |
| 2 | GND | Ground | Ground. |
| 3 | V _{CC} | Power | 5V power supply for internal circuit, connect a 4.7uF capacitor to GND. |
| 4 | DRV | Digital Output | PWM driver. |
| 5 | DIM | Analog Input/Output | Dimming interface connection. |
| 6 | SEL | Analog Input/Output | Connect an external resistor to set max dimming voltage and turn-off threshold voltage. |
| 7 | CF | Analog Input/Output | Sets the PWM output frequency: 100Hz to 5kHz. |
| 8 | SD | Analog Input/Output | Shuts down the IC if voltage is over 0.5V, and programs the minimum duty cycle with a resistor to ground. |

SSL Interface Controller for Analog (0-10V), PWM, and Resistor Dimming with Optocoupler Delay Elimination

5 Absolute Maximum Ratings

Absolute maximum ratings are the parameter values or ranges which can cause permanent damage if exceeded.

| Parameter | Symbol | Value | Units |
|--|------------|-------------|--------------------|
| V_{IN} to GND | V_{IN} | -0.3 to 65 | V |
| V_{CC} to GND (IC internal power supply) | V_{CC} | -0.3 to 6.5 | V |
| DIM to GND | V_{DIM} | -0.3 to 65 | V |
| DRV, CF, SD and SEL to GND | | -0.3 to 6.5 | V |
| ESD rating (HBM) | | ± 2 | kV |
| Storage temperature range | T_{STRG} | 150 | $^{\circ}\text{C}$ |
| Maximum junction temperature | T_{JMAX} | 150 | $^{\circ}\text{C}$ |

SSL Interface Controller for Analog (0-10V), PWM, and Resistor Dimming with Optocoupler Delay Elimination

6 Electrical Characteristics

$V_{IN} = 15V$. All values are at $T_A = +25^\circ C$, unless otherwise specified.

| Parameter | Symbol | Test Conditions | Min | Typ | Max | Unit |
|---------------------------------------|---------------------|--|-----|----------------|-----|---------|
| Power Supply | | | | | | |
| V_{IN} Input Voltage | V_{IN} | | 15 | | 60 | V |
| V_{IN} POR Threshold | V_{IN_POR} | V_{IN} increasing | | 7.5 | | V |
| V_{IN} UVLO Threshold | V_{IN_UVLO} | V_{IN} decreasing | | 6.5 | | V |
| V_{IN} Operating Current | I_{IN} | $V_{IN} = 60V$, No Dimming resistor, No driving | | 500 | | μA |
| V_{IN} Shut-Down Current | I_{IN_SD} | $V_{IN} = 5V$ | | | | μA |
| V_{CC} Output Voltage | V_{CC} | | | 5.2 | | V |
| DIM (PWM Input) | | | | | | |
| Input PWM Frequency | V_{PWM_IN} | | 0.1 | | 5 | kHz |
| Input PWM Amplitude | A_{PWM_IN} | | | | | V |
| Input PWM Detected Duty | $D_{PWM_IN_DET}$ | | | | | % |
| Input PWM Voltage Detected Threshold | $V_{PWM_DET_TH}$ | | | 1.2 | | V |
| Input PWM Voltage Detected Hysteresis | $V_{PWM_DET_HYS}$ | iW350-xx Options | | 50 | | mV |
| | | iW350-xxB/iW350-xxAB Options | | 200 | | |
| DRV | | | | | | |
| DRV Tolerance Voltage | V_{DRV} | | | 5 | | V |
| High Output Voltage | V_{OH} | $I_{SINK} = 50\mu A$ | | $V_{CC} - 0.1$ | | V |
| | | $I_{SINK} = 8mA$ | | $V_{CC} - 0.5$ | | V |
| Low Output Voltage | V_{OL} | $I_{SOURCE} = 50\mu A$ | | 0.1 | | V |
| | | $I_{SOURCE} = 8mA$ | | 0.5 | | V |
| PWM Frequency Tolerance | | | | | | % |
| PWM Duty Tolerance | | | | | | % |
| PWM Output Frequency Range | f_{PWM} | | 0.1 | | 5 | kHz |

SSL Interface Controller for Analog (0-10V), PWM, and Resistor Dimming with Optocoupler Delay Elimination

6 Electrical Characteristics (Cont'd)

$V_{IN} = 15V$. All values are at $T_A = +25^\circ C$, unless otherwise specified.

| Parameter | Symbol | Test Conditions | Min | Typ | Max | Unit |
|---|----------------------|--|-----|------|-----|---------|
| DIM (DC Input) | | | | | | |
| Internal Current Source for 0-10V Dimmer/ R_{DIM} | I_{DIM} | iW350-xxB | | 100 | | μA |
| | | iW350-xxAB | | 150 | | μA |
| Floating Voltage | V_{DIM_FLT} | $V_{IN} = 60V$ | | | | V |
| Turn Off Threshold | $V_{TURN-OFF}$ | Can be set to 0.5V, 0.6V or 0.8V by external resistor (-30 Option) | | 0.7 | | V |
| | | (-32 Option) | | 0.3 | | V |
| Turn Off Hysteresis | $V_{TURN_OFF_HYS}$ | (-30 Option) | | 0.15 | | V |
| | | (-32 Option) | | 0.2 | | V |
| Max. Dimming Voltage | V_{MAX_DIM} | Can be set to 8.5V, 9.5V or 10V by external resistor (-00/-30 Options) | | 9 | | V |
| | | (-02/-32 Options) | | 10 | | V |
| Minimum Duty Limitation (-00/-30 Options) | D_{MIN} | $V_{DIM} \leq 1V$, can be set to 3%, 5% or 10% by external resistor | | 1 | | % |
| Minimum Duty Limitation (-02/-32 Options) | D_{MIN} | $V_{DIM} \leq 0.5V$, can be set to 5% by external resistor | | 1 | | % |
| | | $V_{DIM} = 1V$, can be set by external resistor | | 0 | | % |
| CF | | | | | | |
| CF Pin Current | I_{CF} | (-00/-30 Options) | | 69 | | μA |
| | | (-02/-32 Options) | | 78 | | μA |
| SD | | | | | | |
| V_{SD} Threshold Voltage | V_{SD_TH} | | | 0.5 | | V |
| V_{SD} Threshold Hysteresis | $V_{SD_TH_HYS}$ | V_{IN} decreasing | | 50 | | mV |

SSL Interface Controller for Analog (0-10V), PWM, and Resistor Dimming with Optocoupler Delay Elimination

7 Typical Performance Characteristics

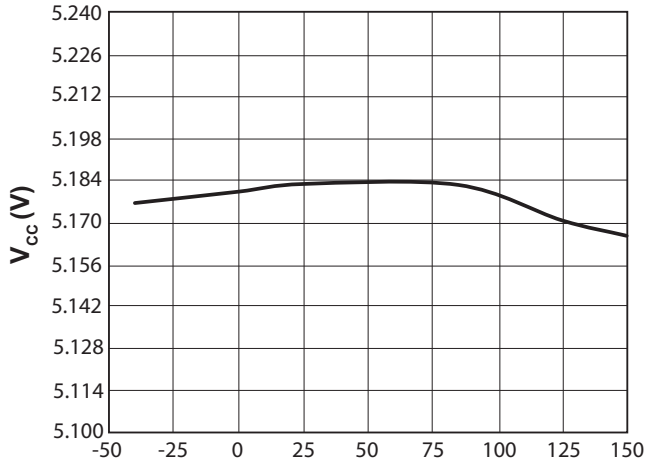

Ambient Temperature (°C)
Figure 7.1 : V_{CC} vs. Temperature

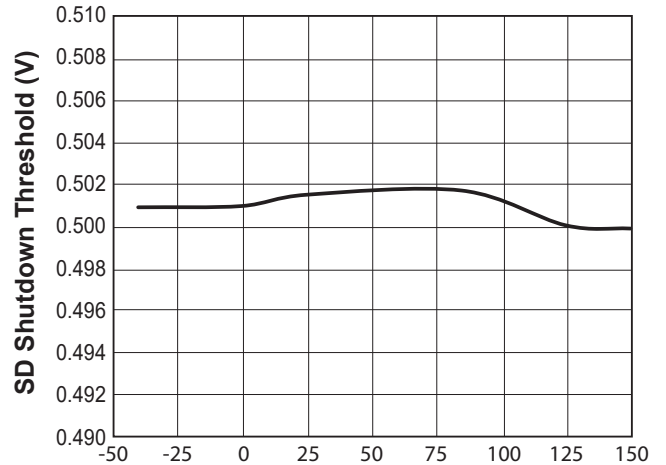

Ambient Temperature (°C)
Figure 7.2 : SD Shutdown Threshold vs. Temperature

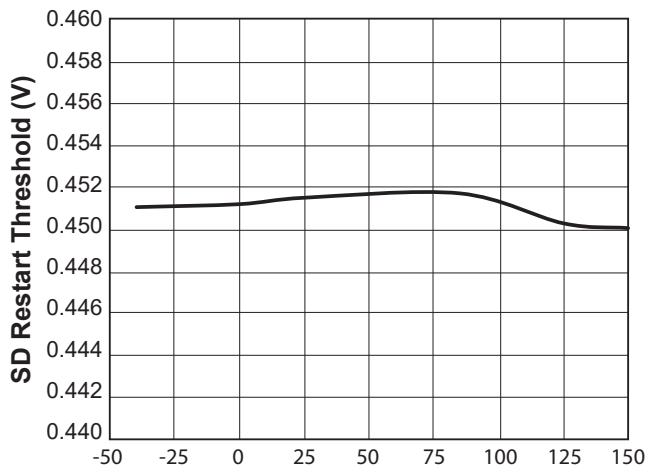

Ambient Temperature (°C)
Figure 7.3 : SD Restart Threshold vs. Temperature

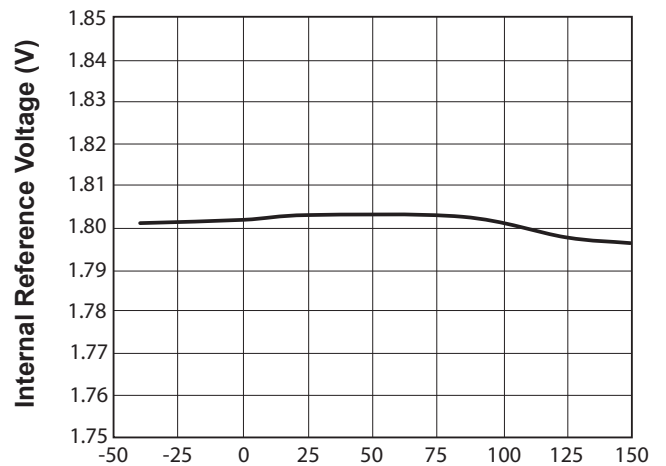

Ambient Temperature (°C)
Figure 7.4 : Reference Voltage vs. Temperature

SSL Interface Controller for Analog (0-10V), PWM, and Resistor Dimming with Optocoupler Delay Elimination

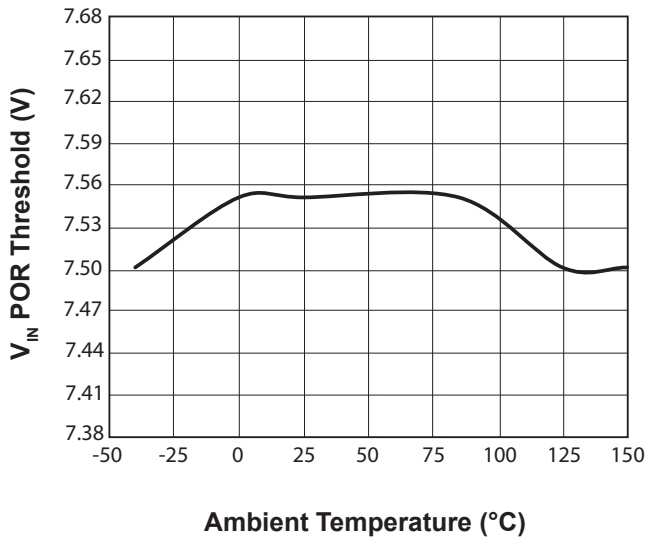

Figure 7.5 : V_{IN} POR Threshold vs. Temperature

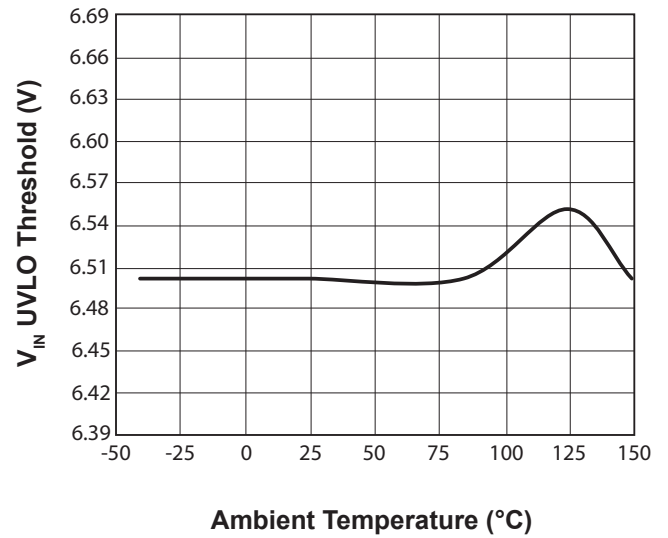

Figure 7.6 : V_{IN} UVLO Threshold vs. Temperature

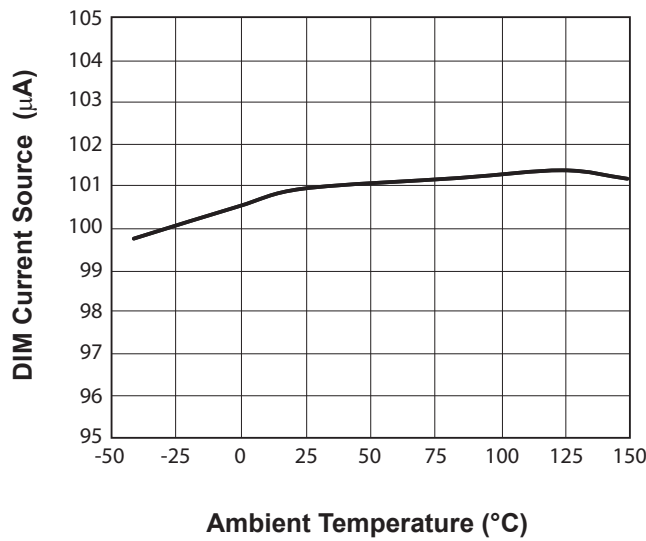

Figure 7.7 : DIM Current Source vs. Temperature

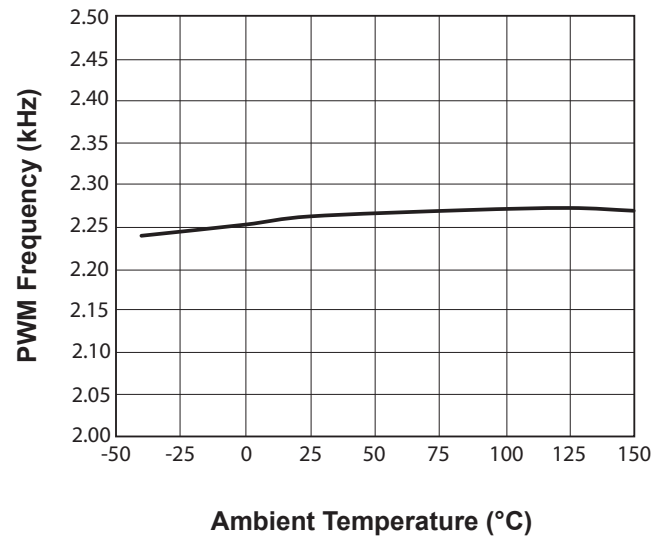

Figure 7.8 : PWM Frequency vs. Temperature¹

⁽¹⁾PWM frequency is set externally via CCF and will vary by application. See section 9.3

SSL Interface Controller for Analog (0-10V), PWM, and Resistor Dimming with Optocoupler Delay Elimination

8 Functional Block Diagram

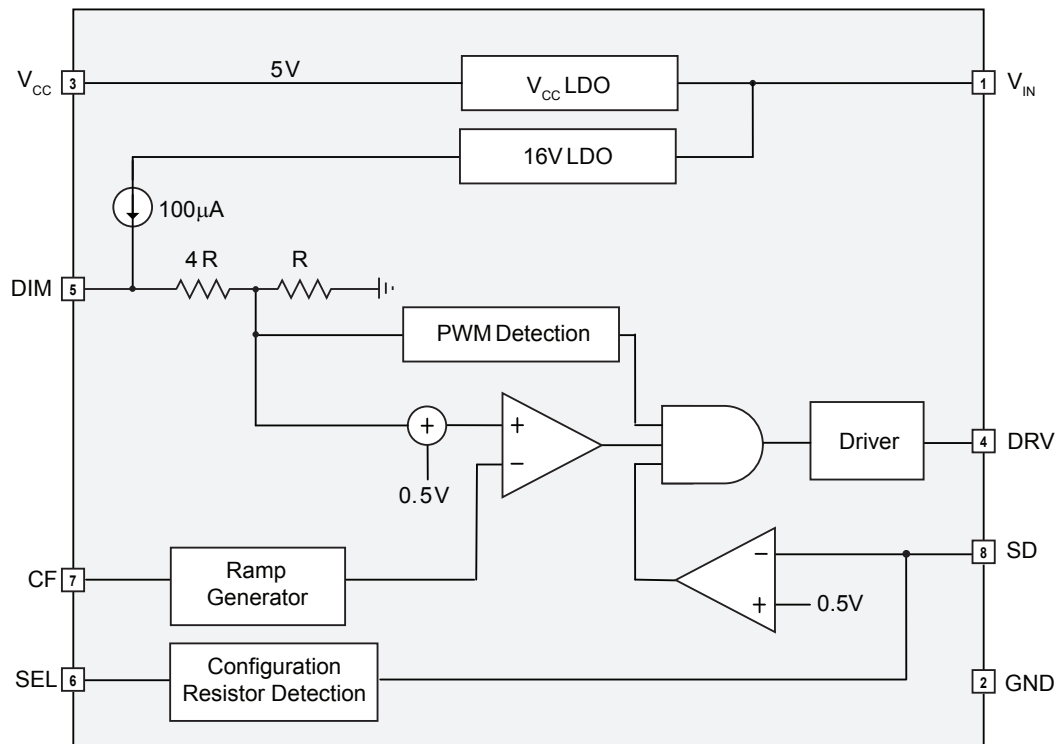

Figure 8.1 : iW350 Functional Block Diagram

9 Theory of Operation

9.1 Overview

The iW350 converts an analog or PWM dimming signal into a PWM signal used to provide a dimming signal to an LED driver. The output of the iW350 can drive an optocoupler or a MOSFET at a configurable frequency determined by an externally set capacitor value. The input analog signal is 0-10V typical. The input duty cycle signal can be auto detected when its amplitude is between 1.8V-10V. The dimming interface can also source a 100µA current to the dimmer, which allows the controller to be compatible with both active and passive dimmers. The iW350 can also set different maximum dimming voltages, minimum output duty cycle values and turn-off threshold voltages through external setting resistors. When driving an optocoupler, the dimming signal can be transferred across the isolation barrier. The iW350 also has a built-in 5V LDO which allows it to work with high input voltages up to 60V.

9.2 Power-on Sequence

The iW350 is powered from the V_{IN} pin. When the V_{IN} voltage is above 7.5V, the iW350 is activated. After an approximately 100ms (max) delay, the iW350 starts to drive the output based on the dimming signal. V_{CC} is regulated to 5.2V through an internal LDO. The operating voltage range of V_{IN} is from 15V to 60V.

9.3 Ramp Generation (-00/-30 Options)

A capacitor C_{CF} is connected to the CF pin to generate the ramp. The CF pin sources 69µA of current to the external capacitor. The voltage across the capacitor increases until it reaches the high threshold of 2.2V. The sourcing current is then disabled. The CF pin starts to sink 69µA current from the capacitor until the CF pin voltage reaches the low limit 0.685V. The PWM frequency can be determined by the following equation:

SSL Interface Controller for Analog (0-10V), PWM, and Resistor Dimming with Optocoupler Delay Elimination

$$f_{PWM} = \frac{175\mu A}{(V_{MAX} - V_{DIM0}) \times C_{CF}} \quad (9.1)$$

Where V_{MAX} is the maximum dimming voltage, C_{CF} is CF pin capacitance value, D_{MIN} is the minimum duty cycle output and V_{DIM0} is defined by equation 9.2.

$$V_{DIM0} = 1 - \left[D_{MIN} \times \frac{(V_{MAX} - 1)}{(1 - D_{MIN})} \right] \quad (9.2)$$

9.4 Ramp Generation (-02/-32 Options)

A capacitor C_{CF} is connected to the CF pin to generate the ramp. The CF pin sources $78\mu A$ of current to the external capacitor. The voltage across the capacitor increases until it reaches the high threshold of 2.5V. The sourcing current is then disabled. The CF pin starts to sink $78\mu A$ current from the capacitor until the CF pin voltage reaches the low limit 0.58V. The PWM frequency can be determined by the following equation:

$$f_{PWM} = \frac{190\mu A}{(10 - V_{DIM0}) \times C_{CF}} \quad (9.3)$$

Where V_{MAX} is the maximum dimming voltage, C_{CF} is CF pin capacitance value, D_{MIN} is the minimum duty cycle output and V_{DIM0} is defined by equation 9.2.

$$V_{DIM0} = 0.5 - \left[D_{MIN} \times \frac{(9.5)}{(1 - D_{MIN})} \right] \quad (9.4)$$

9.5 Dimming Signal Processing

If an analog dimming signal is applied to the DIM pin, the voltage is first divided to 1/5th of the input amplitude. The result is added to a 0.5V offset voltage and then compared with ramp voltage to generate the PWM signal.

When the DIM pin voltage is above the maximum dimming voltage, the PWM duty cycle is 100%. When the DIM pin voltage is below the minimum dimming voltage, the PWM duty cycle output is the minimum output duty. The maximum and minimum dimming voltages that set the maximum and minimum duty cycles are either fixed or programmable, depending upon the product option.

The iW350-00 and iW350-30 offer the ability to program the maximum dimming voltage between 8.5V and 10V, while the iW350-02 and iW350-32 have a fixed maximum dimming voltage, 10V. The minimum duty cycle for the iW350-00 and iW350-30 corresponds to a dimming voltage of 1.0V and can be programmed to 1%, 3%, 5% or 10% duty cycle output. For the iW350-02 and iW350-32, the minimum duty cycle can be set at 0.5V (1% or 5%) or it 0% at 0.1V. Figures 9.1 through 9.4 show the dimming characteristics for the four product options.

If a PWM signal is applied to DIM pin, when its amplitude is from 1.8V to 10V, this signal will be detected and directly output through a driver.

SSL Interface Controller for Analog (0-10V), PWM, and Resistor Dimming with Optocoupler Delay Elimination

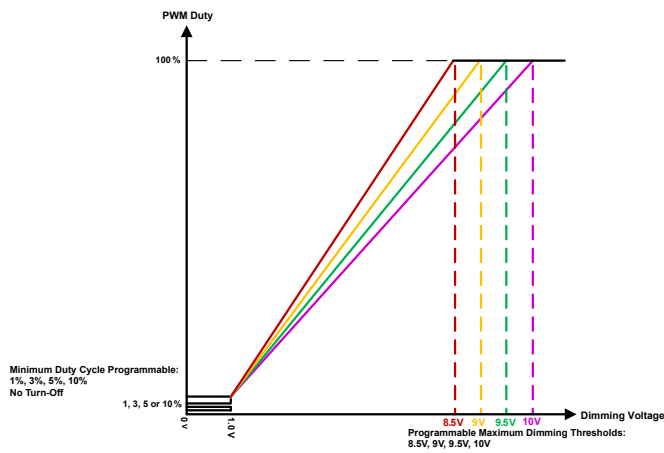

Figure 9.1 : iW350-00 Dimming Characteristics

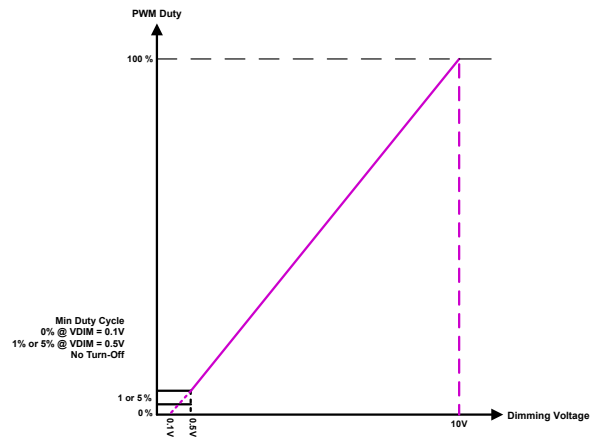

Figure 9.2 : iW350-02 Dimming Characteristics

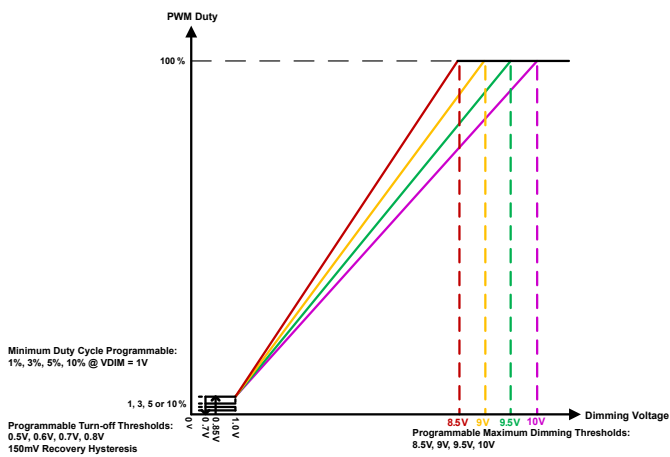

Figure 9.3 : iW350-30 Dimming Characteristics

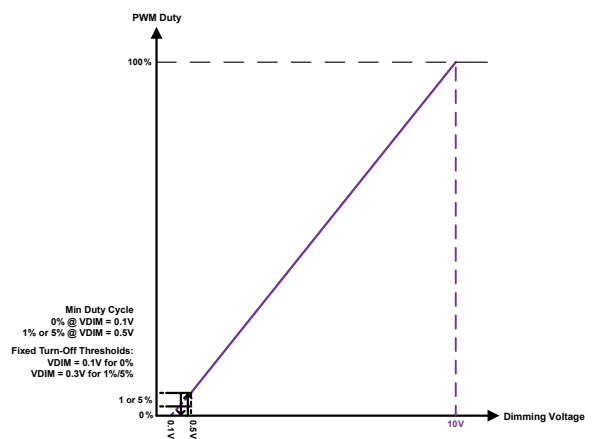

Figure 9.4 : iW350-32 Dimming Characteristics

9.6 Shut Down Protection

The iW350 has a SD pin used for external shut-down function. If the voltage applied to the SD pin is higher than 0.5V, the iW350 output is turned off and enters low power mode.

9.7 Turn-off Function

If the voltage applied to DIM pin is lower than the turn-off threshold voltage, the output of the DRV pin is held “Low” until the voltage is 0.15V higher than the turn-off threshold voltage, and during this time the PWM output of the DRV pin is at the minimum duty cycle output. The turn-off threshold voltage can be set by an external resistor.

The turn-off function is an option, the iW350-30 and iW350-32 have this enabled and the iW350-00 and iW350-02 have this disabled.

SSL Interface Controller for Analog (0-10V), PWM, and Resistor Dimming with Optocoupler Delay Elimination

9.8 External Resistor Configuration Function (-00/-30 Options)

When the iW350 is powered on, it detects the external resistance values between the SEL pin and ground and between the SD pin and the V_{IN} resistor divider, which has a total resistance value of 25k Ω . Different resistance values can set 4 maximum dimming voltage levels, 4 minimum output duty cycle levels and 4 turn-off threshold voltage levels.

| SEL Pin Resistor to Ground | Maximum Dimming Voltage | Turn-off Threshold Voltage |
|----------------------------|-------------------------|----------------------------|
| 0K | 10V | 0.5V |
| 1.4k Ω | | 0.6V |
| 2.32k Ω | | 0.8V |
| 3.48k Ω | | 0.7V |
| 4.99k Ω | 9.5V | 0.5V |
| 6.81k Ω | | 0.6V |
| 9.09k Ω | | 0.8V |
| 11.8k Ω | | 0.7V |
| 15k Ω | 8.5V | 0.5V |
| 19.6k Ω | | 0.6V |
| 24.9k Ω | | 0.8V |
| 36.5k Ω | | 0.7V |
| 51.1k Ω | 9V | 0.5V |
| 69.8k Ω | | 0.6V |
| 93.1k Ω | | 0.8V |
| Floating | | 0.7V |

Table 9.1: iW350 Configuration Resistors for Maximum Dimming Voltage and Turn-off Threshold Voltage (-00/-30 Options)

| SD Pin Series Resistor | Minimum Output Duty Cycle when $V_{DIM} = 1V$ |
|------------------------|---|
| 0 Ω | 1% |
| 56.2k Ω | 3% |
| 133k Ω | 5% |
| 243k Ω | 10% |

Table 9.2: iW350 Configuration Resistors for Minimum Output Duty Cycle when $V_{DIM} = 1V$ (-00/-30 Options)

Note 1: All resistor is 1% accuracy.

Note 2: For SD pin, please connect an external 24.9k Ω set resistor to ground.

9.9 External Configuration Resistors (-02/-32 Options)

For the iW350-02 and iW350-32, different SEL resistance values can set 2 levels of minimum output duty cycle. Table 9.3 shows the resistor configuration options for the SEL pin for the iW350-02 and iW350-32.

The iW350-02 does not have the turn-off function that the iW350-32 offers, but when the device is configured for 0% duty cycle at 0.1V, the output duty cycle will stay low when the DIM pin voltage is lower than 0.1V and stays low until the voltage on the DIM pin reaches 0.25V or higher.

SSL Interface Controller for Analog (0-10V), PWM, and Resistor Dimming with Optocoupler Delay Elimination

| SEL Pin Series Resistor | Minimum Output Duty Cycle when $V_{DIM} = 0.5V$ |
|-------------------------|---|
| Floating | 1% |
| 20k Ω | 5% |
| 0 Ω | No Minimum Output Duty Cycle Limitation |

Table 9.3: iW350 Configuration Resistors for Minimum Output Duty Cycle when $V_{DIM} = 0.5V$ (-02/-32 Options)

SSL Interface Controller for Analog (0-10V), PWM, and Resistor Dimming with Optocoupler Delay Elimination

10 Physical Dimensions

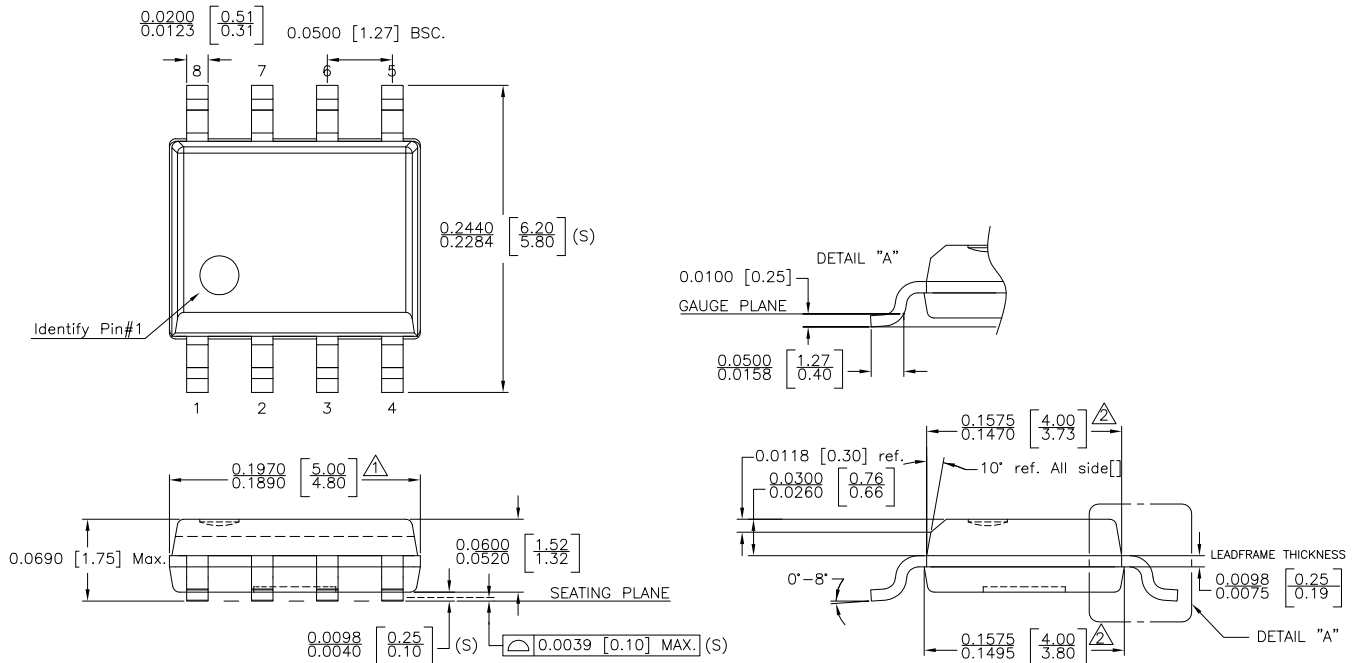

NOTE :

- ⚠ DOES NOT INCLUDE MOLD FLASH, PROTRUSIONS OR GATE BURRS. MOLD FLASH, PROTRUSIONS AND GATE BURRS SHALL NOT EXCEED .006 INCH PER SIDE.
- ⚠ DOES NOT INCLUDE INTER-LEAD FLASH OR PROTRUSIONS. INTER-LEAD FLASH AND PROTRUSIONS SHALL NOT EXCEED .010 INCH PER SIDE.
- 3. THIS PART IS COMPLIANT WITH JEDEC SPECIFICATION MS-012.
- 4. LEAD SPAN/STAND OFF HEIGHT/COPLANARITY ARE CONSIDERED AS SPECIAL CHARACTERISTIC(S)
- 5. CONTROLLING DIMENSIONS IN INCHES. [mm]

| | |
|--|------------------------|
| | |
| STATUS: RELEASED | SCALE: DO NOT SCALE |
| TERMINAL FINISH: 100% Sn or NiPdAu (PPF) | |
| TITLE: 8 SOIC PACKAGE OUTLINE | |
| REV: D | DATE: 18-JUN-2020 |
| REVISION NOTE: EJECTOR CHANGED TO DASHED LINE | |

Figure 10.1 : Physical Dimensions of 8-Pin SOIC Package

11 Ordering Information

| Part Number | Options | Package | Description |
|--|---|---------|--------------------------|
| iW350-00 ¹ iW350-00B iW350-00AB | Standard PWM Output; Dimming Curve Figure 9.1; Turn-off Function Disabled | SOIC-8 | Tape & Reel ² |
| iW350-02 ¹ iW350-02B iW350-02AB | Standard PWM Output; Dimming Curve Figure 9.2; Turn-off Function Disabled | SOIC-8 | Tape & Reel ² |
| iW350-30 ¹ iW350-30B iW350-30AB | Standard PWM Output; Dimming Curve Figure 9.3; Turn-off Function Enabled | SOIC-8 | Tape & Reel ² |
| iW350-32 ¹ iW350-32B | Standard PWM Output; Dimming Curve Figure 9.4; Turn-off Function Enabled | SOIC-8 | Tape & Reel ² |

Note 1. Not recommended for new designs, please use the -xxB version.

Note 2. Tape and reel packing quantity is 2,500/reel. Minimum packing quantity is 2,500.

SSL Interface Controller for Analog (0-10V), PWM, and Resistor Dimming with Optocoupler Delay Elimination

Disclaimer

Unless otherwise agreed in writing, the Dialog Semiconductor products (and any associated software) referred to in this document are not designed, authorized or warranted to be suitable for use in life support, life-critical or safety-critical systems or equipment, nor in applications where failure or malfunction of a Dialog Semiconductor product (or associated software) can reasonably be expected to result in personal injury, death or severe property or environmental damage. Dialog Semiconductor and its suppliers accept no liability for inclusion and/or use of Dialog Semiconductor products (and any associated software) in such equipment or applications and therefore such inclusion and/or use is at the customer's own risk.

Information in this document is believed to be accurate and reliable. However, Dialog Semiconductor does not give any representations or warranties, express or implied, as to the accuracy or completeness of such information. Dialog Semiconductor furthermore takes no responsibility whatsoever for the content in this document if provided by any information source outside of Dialog Semiconductor.

Dialog Semiconductor reserves the right to change without notice the information published in this document, including, without limitation, the specification and the design of the related semiconductor products, software and applications. Notwithstanding the foregoing, for any automotive grade version of the device, Dialog Semiconductor reserves the right to change the information published in this document, including, without limitation, the specification and the design of the related semiconductor products, software and applications, in accordance with its standard automotive change notification process.

Applications, software, and semiconductor products described in this document are for illustrative purposes only. Dialog Semiconductor makes no representation or warranty that such applications, software and semiconductor products will be suitable for the specified use without further testing or modification. Unless otherwise agreed in writing, such testing or modification is the sole responsibility of the customer and Dialog Semiconductor excludes all liability in this respect.

Nothing in this document may be construed as a license for customer to use the Dialog Semiconductor products, software and applications referred to in this document. Such license must be separately sought by customer with Dialog Semiconductor.

All use of Dialog Semiconductor products, software and applications referred to in this document is subject to Dialog Semiconductor's [Standard Terms and Conditions of Sale](#), available on the company website (www.dialog-semiconductor.com) unless otherwise stated.

Dialog, Dialog Semiconductor and the Dialog logo are trademarks of Dialog Semiconductor Plc or its subsidiaries. All other product or service names and marks are the property of their respective owners.

© 2021 Dialog Semiconductor. All rights reserved.

RoHS Compliance

Dialog Semiconductor's suppliers certify that its products are in compliance with the requirements of Directive 2011/65/EU of the European Parliament on the restriction of the use of certain hazardous substances in electrical and electronic equipment. RoHS certificates from our suppliers are available on request.

Contacting Dialog Semiconductor

United Kingdom (Headquarters)
Dialog Semiconductor (UK) LTD
Phone: +44 1793 757700

Germany
Dialog Semiconductor GmbH
Phone: +49 7021 805-0

The Netherlands
Dialog Semiconductor B.V.
Phone: +31 73 640 8822

Email
info_pcbg@diasemi.com

North America
Dialog Semiconductor Inc.
Phone: +1 408 845 8500

Japan
Dialog Semiconductor K. K.
Phone: +81 3 5769 5100

Taiwan
Dialog Semiconductor Taiwan
Phone: +886 281 786 222

Web site:
www.dialog-semiconductor.com

Hong Kong
Dialog Semiconductor Hong Kong
Phone: +852 2607 4271

Korea
Dialog Semiconductor Korea
Phone: +82 2 3469 8200

China (Shenzhen)
Dialog Semiconductor China
Phone: +86 755 2981 3669

China (Shanghai)
Dialog Semiconductor China
Phone: +86 21 5424 9058